

<b>Material, Oberfläche</b> finish	<b>Verpackungseinheit</b> packing unit	<b>Version</b> version	<b>EDV-Nr.</b> EDP-No.	<b>Kat.-Preis</b> EUR per
---------------------------------------	---	---------------------------	---------------------------	------------------------------

**Rampenprofil für den Objektbereich, Aluminium, 10,5 - 13 mm für Schwerlasten, 10,5 - 15 mm für Rollstühle etc.**  
**Ramp profile for public areas, Aluminium, 10.5 - 13 mm for heavy weights, 10.5 - 15 mm for wheel chairs etc.**

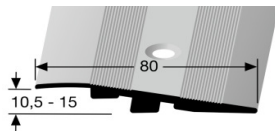

**260DE30**

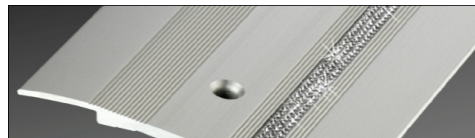

**Mit eingefassten 3-reihigen  
SWAROVSKI ELEMENTS  
Kristallen**

**With edged SWAROVSKI  
ELEMENTS  
crystals (three rows)**

silber silver	20 x 2,7 = 54,0 m		345 260 134 5	126,05 m
edelstahloptik stainless steel optic	20 x 2,7 = 54,0 m		345 260 132 5	127,10 m

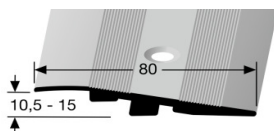

**260DE20**

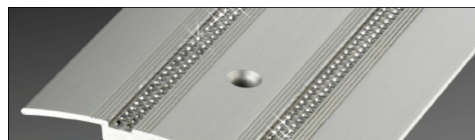

**Mit zwei eingefassten  
SWAROVSKI ELEMENTS  
Kristallen (zweireihig)**

**With two edged  
SWAROVSKI ELEMENTS  
crystals (two rows)**

silber silver	20 x 2,7 = 54,0 m		345 260 224 5	173,05 m
edelstahloptik stainless steel optic	20 x 2,7 = 54,0 m		345 260 222 5	174,05 m

<b>Material, Oberfläche</b> finish	<b>Verpackungseinheit</b> packing unit	<b>Version</b> version	<b>EDV-Nr.</b> EDP-No.	<b>Kat.-Preis</b> EUR per
---------------------------------------	---	---------------------------	---------------------------	------------------------------

**Rampenprofil für den Objektbereich, Aluminium, 8,5 - 13 mm für Schwerlasten, 8,5 - 15 mm für Rollstühle etc.**  
**Ramp profile for public areas, Aluminium, 8.5 - 13 mm for heavy weights, 8.5 - 15 mm for wheel chairs etc.**

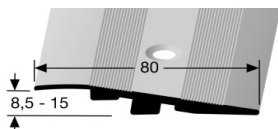

**268DE30**

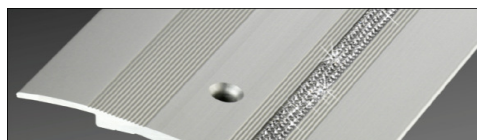

**Mit eingefassten 3-reihigen  
SWAROVSKI ELEMENTS  
Kristallen**

**With edged SWAROVSKI  
ELEMENTS crystals (three  
rows)**

silber silver	20 x 2,7 = 54,0 m		345 268 134 5	126,05 m
edelstahloptik stainless steel optic	20 x 2,7 = 54,0 m		345 268 132 5	127,10 m

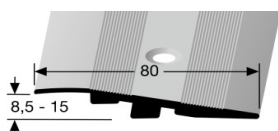

**268DE20**

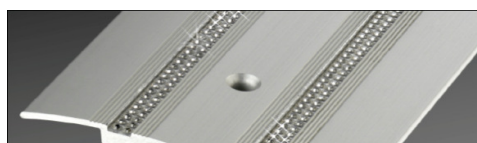

**Mit zwei eingefassten  
SWAROVSKI ELEMENTS  
Kristallen (zweireihig)**

**With two edged  
SWAROVSKI ELEMENTS  
crystals  
(two rows)**

silber silver	20 x 2,7 = 54,0 m		345 268 224 5	173,05 m
edelstahloptik stainless steel optic	20 x 2,7 = 54,0 m		345 268 222 5	174,05 m



**Lieferzeit ca. 3 - 4 Wochen ab Werk**

**Delivery time approx. 3 - 4 weeks ex works**

<b>Material, Oberfläche</b> finish	<b>Verpackungseinheit</b> packing unit	<b>Version</b> version	<b>EDV-Nr.</b> EDP-No.	<b>Kat.-Preis</b> EUR per
---------------------------------------	---	---------------------------	---------------------------	------------------------------

**Standard-Treppenkantenprofil DEKO-TK, Aluminium, versenkt gebohrt, für den privaten Bereich**  
**Standard stair nosings DEKO-TK, aluminium, with countersunk holes, for residential use**

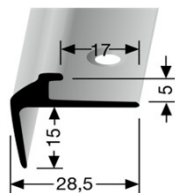

850DE20

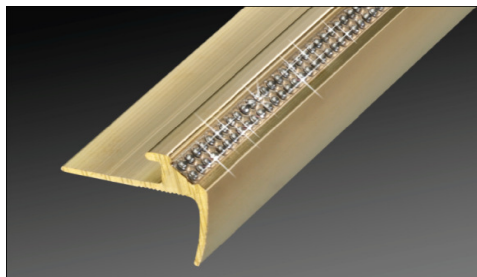

Mit eingefassten  
**SWAROVSKI ELEMENTS**  
Kristallen (zweireihig)  
  
With edged  
**SWAROVSKI ELEMENTS**  
crystals  
(two rows)

silber silver	20 x 2,5 = 50,0 m		345 850 124 4	87,95 m
edelstahloptik stainless steel optic	20 x 2,5 = 50,0 m		345 850 122 4	88,80 m
Messing poliert brass polished	20 x 2,5 = 50,0 m		345 850 127 4	108,75 m

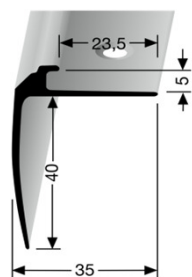

852DE20

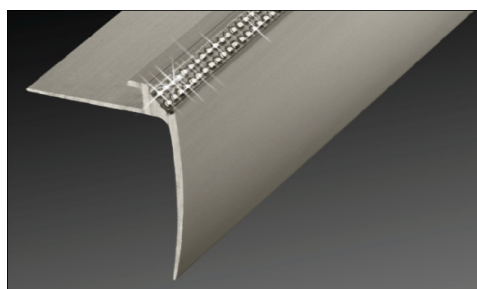





Mit eingefassten  
**SWAROVSKI ELEMENTS**  
Kristallen (zweireihig)  
  
With edged  
**SWAROVSKI ELEMENTS**  
crystals  
(two rows)

silber silver	20 x 2,5 = 50,0 m		345 852 124 4	90,45 m
edelstahloptik stainless steel optic	20 x 2,5 = 50,0 m		345 852 122 4	90,85 m

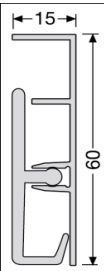

Lieferzeit ca. 3 - 4 Wochen ab Werk

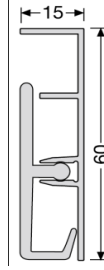
Delivery time approx. 3 - 4 weeks ex works

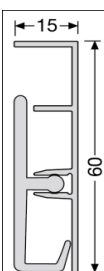
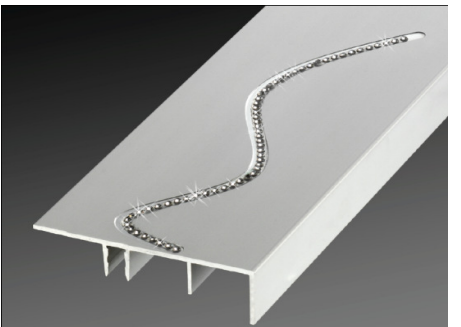
Material, Oberfläche finish	Verpackungseinheit packing unit	Version version	EDV-Nr. EDP-No.	Kat.-Preis EUR per				
<b>Aluminium Sockelleisten</b> , eloxiert, inklusive Befestigungsmittel <b>Aluminium Deco Base Board</b> , anodized, with all the fastening material								
<b>935DE01</b> Höhe/height: 60 mm   inkl. Wandhalter, Schrauben und Dübel incl. wall holder, screws and dowels		<b>Geradliniges Design aufgewertet mit klaren, viereckigen SWAROVSKI ELEMENTS Kristallen (10 Stück je Meter)</b>  <b>Linear design, upgraded with clear, rectangular SWAROVSKI ELEMENTS crystals (10 pieces per meter)</b>						
		silber	10	x	2,50 = 25,00 m	SBS	345 935 164 4	41,60 m
		edelstahloptik f. geschl. stainless steel optic f.g.	10	x	2,50 = 25,00 m	SBS	345 935 162 4	43,60 m
<b>935DE02</b> Höhe/height: 60 mm   inkl. Wandhalter, Schrauben und Dübel incl. wall holder, screws and dowels		<b>Geradliniges Design aufgewertet mit runden SWAROVSKI ELEMENTS Kristallen im Farbton "Golden Shadow" (10 Stück je Meter)</b>  <b>Linear design, upgraded with round SWAROVSKI ELEMENTS crystals color "Golden Shadow" (10 pieces per meter)</b>						
		silber	10	x	2,50 = 25,00 m	SBS	345 935 144 4	38,85 m
		edelstahloptik f. geschl. stainless steel optic f.g.	10	x	2,50 = 25,00 m	SBS	345 935 142 4	40,85 m
<b>935DE03</b> Höhe/height: 60 mm   inkl. Wandhalter, Schrauben und Dübel incl. wall holder, screws and dowels		<b>Geschwungene Formen veredelt mit einreihigem SWAROVSKI ELEMENTS Kristallen</b>  <b>Curved shapes refinded with single-row SWAROVSKI ELEMENTS crystals</b>						
		silber	10	x	2,50 = 25,00 m	SBS	345 935 244 4	67,35 m
		edelstahloptik f. geschl. stainless steel optic f.g.	10	x	2,50 = 25,00 m	SBS	345 935 242 4	69,35 m

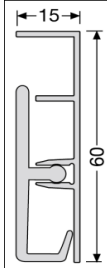
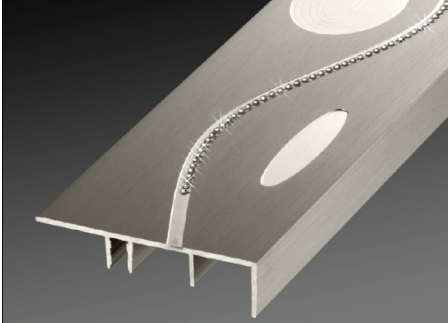
Material, Oberfläche finish	Verpackungseinheit packing unit	Version version	EDV-Nr. EDP-No.	Kat.-Preis EUR per	
<b>935DE04</b> Höhe/height: 60 mm			<p><b>Phantasievolles Design veredelt mit einreihigen SWAROVSKI ELEMENTS Kristallen</b></p> <p><b>Fanciful design refined with single row SWAROVSKI ELEMENTS crystals</b></p>		
					silber
edelstahloptik f. geschl. stainless steel optic f.g.	10 x 2,50 = 25,00 m	m	SBS	345 935 342 4	79,05 m

**Aluminium End- und Eckstücke für 935**  
**Aluminium end caps and corners for 935**

935FDE01



**Hochwertige Verbindungselemente mit 4 klaren, runden SWAROVSKI ELEMENTS Kristallen**  
*Bei den Endstücken wahlweise auf Vorderseite oder an den Seiten.*

**High-quality connectors with 4 clear, round SWAROVSKI ELEMENTS crystals**  
*For the end caps optionally on the front or on side.*

Endstück links, Vorne end cap left, front	silber	für / for 935	SB	045 935 814 9	22,15 St
	edelstahloptik f. geschl. stainless steel optic f.g.		SB	045 935 812 9	23,45 St
Endstück links, Seite end cap left, side	silber	für / for 935	SB	045 935 884 9	22,15 St
	edelstahloptik f. geschl. stainless steel optic f.g.		SB	045 935 882 9	23,45 St
Endstück rechts, Vorne end cap right, front	silber	für / for 935	SB	045 935 824 9	22,15 St
	edelstahloptik f. geschl. stainless steel optic f.g.		SB	045 935 822 9	23,45 St
Endstück rechts, Seite end cap right, side	silber	für / for 935	SB	045 935 894 9	22,15 St
	edelstahloptik f. geschl. stainless steel optic f.g.		SB	045 935 892 9	23,45 St
Außenecke external corner	silber	für / for 935	SB	045 935 834 9	25,30 St
	edelstahloptik f. geschl. stainless steel optic f.g.		SB	045 935 832 9	26,40 St
Innenecke internal corner	silber	für / for 935	SB	045 935 844 9	31,20 St
	edelstahloptik f. geschl. stainless steel optic f.g.		SB	045 935 842 9	32,50 St
Verbindungselement connecting unit	silber	für / for 935	SB	045 935 854 9	27,25 St
	edelstahloptik f. geschl. stainless steel optic f.g.		SB	045 935 852 9	28,85 St
Außenecke 135 ° internal corner 135 °	silber	für / for 935	SB	045 935 864 9	57,55 St
	edelstahloptik f. geschl. stainless steel optic f.g.		SB	045 935 862 9	59,60 St

<b>Material, Oberfläche</b> finish	<b>Verpackungseinheit</b> packing unit	<b>Version</b> version	<b>EDV-Nr.</b> EDP-No.	<b>Kat.-Preis</b> EUR per
---------------------------------------	---	---------------------------	---------------------------	------------------------------

**Aluminium End- und Eckstücke für 935**  
**Aluminium end caps and corners for 935**  
**935FDE02**



Hochwertige Verbindungselemente mit 4 **farbigen** (Golden Shadow), runden SWAROVSKI ELEMENTS Kristallen  
*Bei den Endstücken wahlweise auf Vorderseite oder an den Seiten.*

High-quality connectors with 4 **coloured** (Golden Shadow), round SWAROVSKI ELEMENTS  
*For the end caps optionally on the front or on side.*

Endstück links, Vorne end cap left, front	silber	für / for 935	SB	045 935 914 9	24,15 St
	silber edelstahloptik f. geschl. stainless steel optic f.g.		SB	045 935 912 9	25,45 St
Endstück links, Seite end cap left, side	silber	für / for 935	SB	045 935 984 9	24,15 St
	silber edelstahloptik f. geschl. stainless steel optic f.g.		SB	045 935 982 9	25,45 St
Endstück rechts, Vorne end cap right, front	silber	für / for 935	SB	045 935 924 9	24,15 St
	silber edelstahloptik f. geschl. stainless steel optic f.g.		SB	045 935 922 9	25,45 St
Endstück rechts, Seite end cap right, side	silber	für / for 935	SB	045 935 994 9	24,15 St
	silber edelstahloptik f. geschl. stainless steel optic f.g.		SB	045 935 992 9	25,45 St
Außenecke external corner	silber	für / for 935	SB	045 935 934 9	27,30 St
	silber edelstahloptik f. geschl. stainless steel optic f.g.		SB	045 935 932 9	28,45 St
Innenecke internal corner	silber	für / for 935	SB	045 935 944 9	33,20 St
	silber edelstahloptik f. geschl. stainless steel optic f.g.		SB	045 935 942 9	34,50 St
Verbindungselement connecting unit	silber	für / for 935	SB	045 935 954 9	29,25 St
	silber edelstahloptik f. geschl. stainless steel optic f.g.		SB	045 935 952 9	30,85 St
Außenecke 135 ° internal corner 135 °	silber	für / for 935	SB	045 935 964 9	59,55 St
	silber edelstahloptik f. geschl. stainless steel optic f.g.		SB	045 935 962 9	61,60 St



**Lieferzeit ca. 3 - 4 Wochen ab Werk**

**Delivery time approx. 3 - 4 weeks ex works**

<b>Material, Oberfläche</b> finish	<b>Verpackungseinheit</b> packing unit	<b>Version</b> version	<b>EDV-Nr.</b> EDP-No.	<b>Kat.-Preis</b> EUR per
---------------------------------------	---	---------------------------	---------------------------	------------------------------

**Aluminium Heizrohrrosetten**  
**Aluminium heating tube rosette**

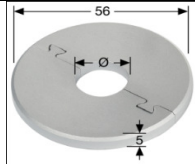

ZR01



**Mit 10 strahlenden, klaren  
Kristallen  
SWAROVSKI ELEMENTS**

**With 10 shiny, clear crystals  
SWAROVSKI ELEMENTS**

Rohrdurchmesser 12 mm Tube diameter	silber	Ø = 12 mm	SB	045 051 124 9	24,15 St
	edelstahloptik f. geschl. stainless steel optic f.g.	Ø = 12 mm	SB	045 051 122 9	26,50 St
Rohrdurchmesser 15 mm Tube diameter	silber	Ø = 15 mm	SB	045 051 154 9	24,15 St
	edelstahloptik f. geschl. stainless steel optic f.g.	Ø = 15 mm	SB	045 051 152 9	26,50 St
Rohrdurchmesser 18 mm Tube diameter	silber	Ø = 18 mm	SB	045 051 184 9	24,15 St
	edelstahloptik f. geschl. stainless steel optic f.g.	Ø = 18 mm	SB	045 051 182 9	26,50 St
Rohrdurchmesser 22 mm Tube diameter	silber	Ø = 22 mm	SB	045 051 224 9	24,15 St
	edelstahloptik f. geschl. stainless steel optic f.g.	Ø = 22 mm	SB	045 051 222 9	26,50 St

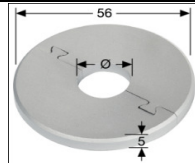

ZR03



**Die Kristalle werten die  
hochwertige Heizkörperrosette  
noch einmal auf.**

**The crystals valorize the  
high-quality heating tube**

Rohrdurchmesser 12 mm Tube diameter	silber	Ø = 12 mm	SB	045 052 124 9	24,15 St
	edelstahloptik f. geschl. stainless steel optic f.g.	Ø = 12 mm	SB	045 052 122 9	26,50 St
Rohrdurchmesser 15 mm Tube diameter	silber	Ø = 15 mm	SB	045 052 154 9	24,45 St
	edelstahloptik f. geschl. stainless steel optic f.g.	Ø = 15 mm	SB	045 052 152 9	26,85 St
Rohrdurchmesser 18 mm Tube diameter	silber	Ø = 18 mm	SB	045 052 184 9	24,75 St
	edelstahloptik f. geschl. stainless steel optic f.g.	Ø = 18 mm	SB	045 052 182 9	27,15 St
Rohrdurchmesser 22 mm Tube diameter	silber	Ø = 22 mm	SB	045 052 224 9	25,20 St
	edelstahloptik f. geschl. stainless steel optic f.g.	Ø = 22 mm	SB	045 052 222 9	27,55 St

Material, Oberfläche finish	Verpackungseinheit packing unit	Version version	EDV-Nr. EDP-No.	Kat.-Preis EUR per
--------------------------------	------------------------------------	--------------------	--------------------	-----------------------

**Türstopper Messing**, massiv, mit patentiertem Dübelsystem oder mit Stockschraube  
**Door stopper brass**, solid, with patented dowel system or grub screw

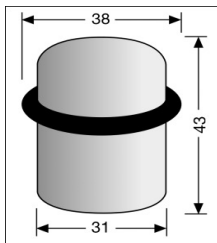

Messing glanz vernickelt brass nickel-plated brilliant	1 St	SB	045 055 114 9	37,10 St
Messing poliert brass polished	1 St	SB	045 055 115 9	37,10 St
<b>ZT05</b> Messing matt vernickelt brass nickel-plated matt	1 St	SB	045 055 112 9	37,10 St

**Türstopper aus Messing mit, umlaufenden  
einzigartigen SWAROVSKI ELEMENTS  
Kristallen**

**Door stopper brass with circulating unique  
SWAROVSKI ELEMENTS crystals**

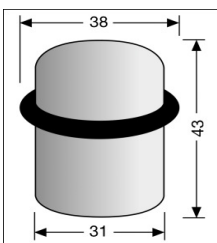

Messing glanz vernickelt brass nickel-plated brilliant	1 St	SB	045 055 214 9	42,45 St
Messing poliert brass polished	1 St	SB	045 055 215 9	42,45 St
<b>ZT01</b> Messing matt vernickelt brass nickel-plated matt	1 St	SB	045 055 212 9	42,45 St

**Türstopper aus Messing mit einem klaren,  
einzigartigen SWAROVSKI ELEMENTS  
Kristall**

**Door stopper brass with on e clear, unique  
SWAROVSKI ELEMENTS crystal**

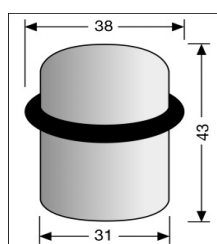

Messing glanz vernickelt brass nickel-plated brilliant	1 St	SB	045 055 254 9	42,45 St
Messing poliert brass polished	1 St	SB	045 055 255 9	42,45 St
<b>ZT03</b> Messing matt vernickelt brass nickel-plated matt	1 St	SB	045 055 252 9	42,45 St

**Türstopper aus Messing mit einem edlen,  
farbigen SWAROVSKI ELEMENTS Kristall**

**Door Stopper brass with one noble,  
colored  
SWAROVSKI ELEMENTS cystal**

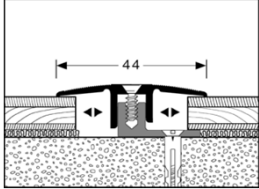

	Farbe colour	Länge/Length m	EDV-Nr. EDP-No.	Kat.-Preis EUR per
Übergangsprofil Connecting profile <b>388DE01 (7 - 18 mm)</b>	silber silver	2,70	045 388 104 5	51,10 m
		3,00	045 388 104 8	51,10 m
	F4			
	edelstahloptik stainelss steel optic	2,70	045 388 102 5	51,90 m
		3,00	045 388 102 8	51,90 m
	F2			



Die vielseitige Verlegelösung mit  
exklusivem Wellendesign.

The multi-purpose laying solution  
with exclusive wave design



Lieferzeit ca. 3 - 4 Wochen ab Werk  
Delivery time approx. 3 - 4 weeks ex works